

# Smart Speed-Mat®

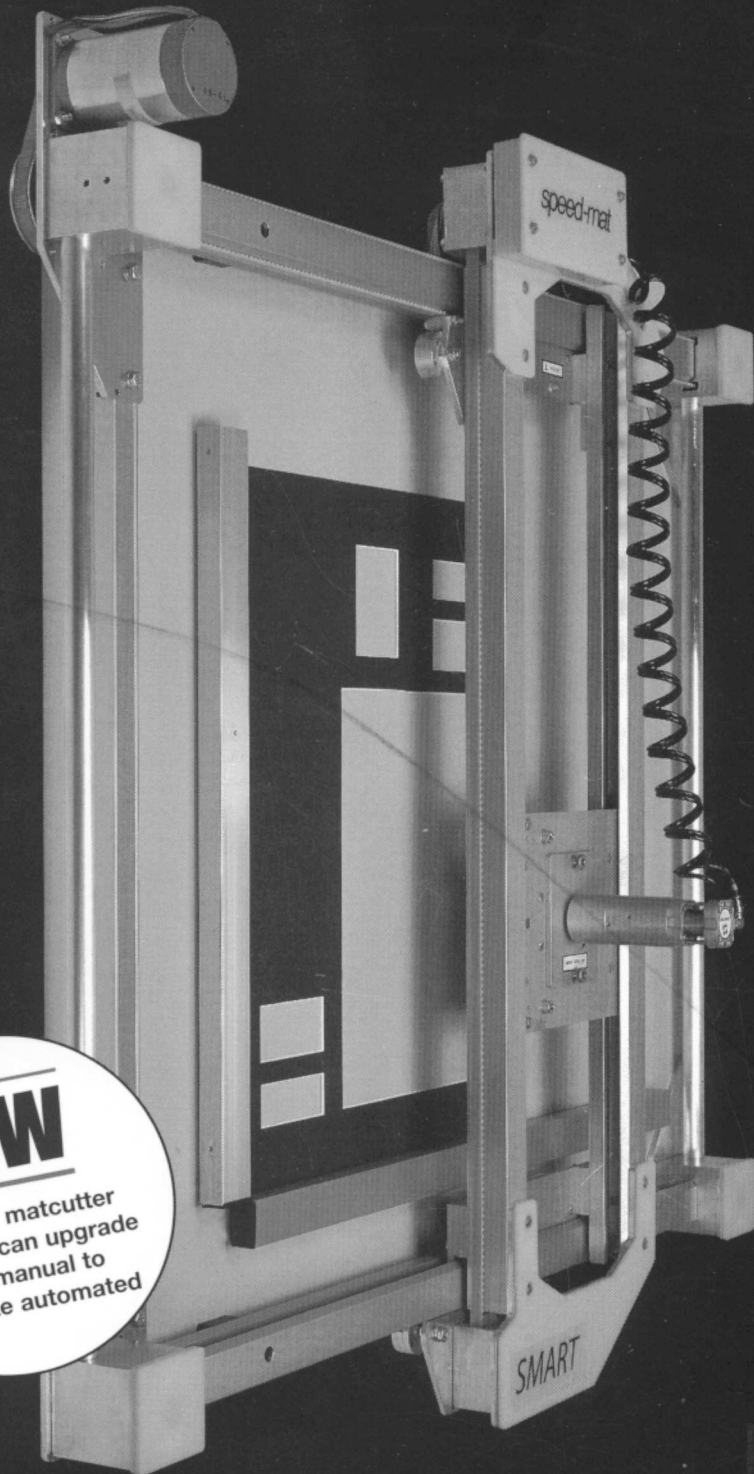

**NEW**

The only matcutter  
wich you can upgrade  
from manual to  
complete automated

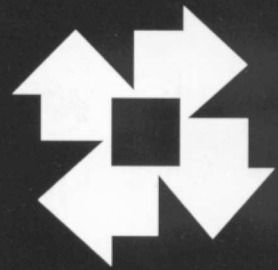

**speed-mat®**

MAT CUTTING SYSTEMS

Speed-Mat International

Parallelweg 30  
5223 AL 's-Hertogenbosch  
The Netherlands  
Phone: +31 (0)73 513 05 07  
Fax: +31 (0)73 513 04 89  
E-mail: [speed-mat.int@introweb.nl](mailto:speed-mat.int@introweb.nl)  
Web site: [www.speed-mat.com](http://www.speed-mat.com)

**Now available:  
Smart upgrade kit**

The Speed-Mat is available  
in 3 sizes: 80 x 100 cm,  
100 x 120 cm and 100 x 150 cm

In 1974 we introduced the Speed-Mat rectangle cutter. Speed-Mat's unique 4-way rectangle knife head cuts a beveled mat in 4 consecutive cuts without marking or turning the mat.

The new Smart Speed-Mat is a logical enhancement of this original manual Speed-Mat.

The Smart Speed-Mat will provide a major improvement in efficiency for cutting standard rectangle openings. The machine operates with a micro controller with LCD display and keyboard .

The Smart Speed-Mat is available as a complete machine, or as an upgrade kit which can be installed on any Speed-Mat rectangle cutter, even one that is 25 years old !

The Smart Speed-Mat will cut single, double

and multiple mat openings. Mats may also be sized (bevelcut). The standard the Smart Speed-Mat comes with a micro controller for entering border and opening sizes.

Also the Smart Speed-Mat may be connected

with any standard Windows computer.  
Do it Smart with a Speed-Mat

## Options

S433.0 rectangle 45° knifehead  
 S455.0 rectangle / oval / circle  
 knifehead

S434.0 rectangle 60° knifehead  
 S435.0 90° knifehead

S200.0 Windows software

S500.0 floorstand vertical

S500.1 floorstand horizontal

## Blades

448.1 box blades 100

449.1 box blades 500

## Upgrade kit

100.3 complete automatic Smart kit  
 (without knifehead)

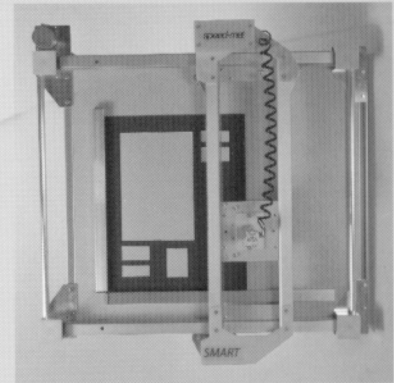
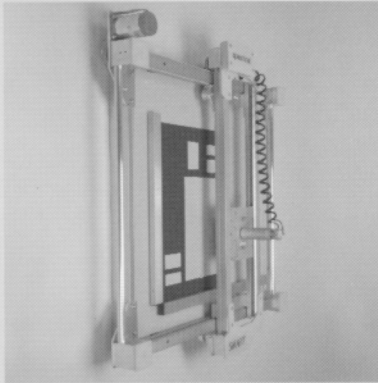

### Standard equipment specifications:

- 100 blades
- 2 shelf brackets for wall installation
- 3 hexagonal keys
- Manual in English
- LCD display with keyboard
- Software: single, double and multi openings
- Outside dimensions in bevel cut

### Technical data:

type	matboard size	outside dimensions	weight
A3240	80 x 100 cm	117 x 115 cm	60kg
A4048	100 x 120 cm	117 x 156 cm	60kg
A4060	100 x 150 cm	117 x 188 cm	73kg

### Specifications:

- 4 phase motors
- cutting speed 500mm/sec
- pneumatic 4 Bar
- clamps board automatically
- repeat button for production

### Options:

- cutting table horizontal or vertical
- system measure metric or inches
- electronic system: 115V or 230V
- sizes: 80 x 100 cm, 100 x 120 cm or 100 x 150 cm
- knifehead: rectangle or rectangle oval, circle

### Software:

Standard software included  
 Single, double and multi opening  
 Outside dimensions in bevelcut  
 Windows software (S200.0)  
 It is possible to connect LCD with Windows computer: Windows software (S200.0)

## Smart upgrade kit 100.3

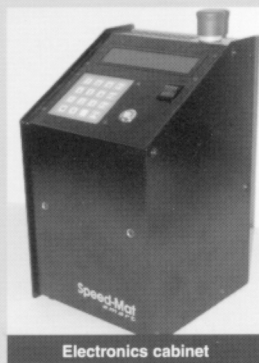

Electronics cabinet

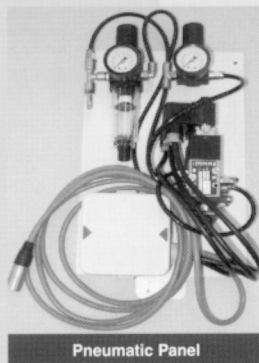

Pneumatic Panel

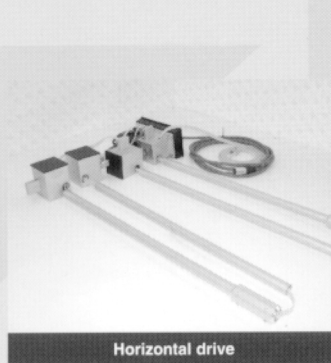

Horizontal drive

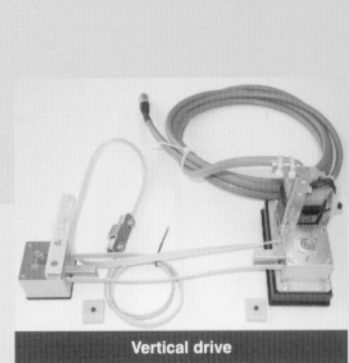

Vertical drive

### Smart upgrade kit 100.3

Complete kit to upgrade your manual machine to Smart automatic. With standard tools you can upgrade your machine in approx 6 hours to complete automatic. The Smart upgrade kit is complete, but without knifehead.